

Lifting force tables EZ38

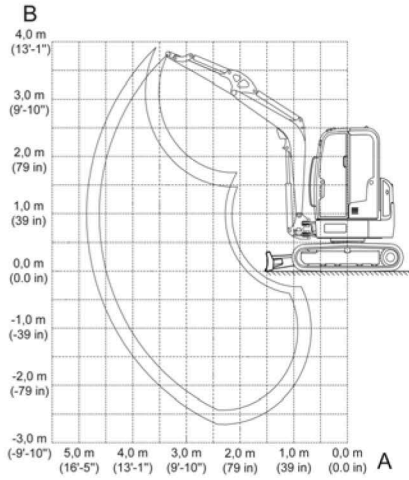





Fig. 1: Lifting force table EZ38

Designation	Explanation
A	Outreach from middle of rotating assembly
B	Load hook height
max	Permissible weight or mass value with extended arm system
	With or without dozer blade support in travel direction
	With or without dozer blade support 90° to the travel direction
	Dozer blade down
	Dozer blade up

All table values are specified in kg (lbs.), in a horizontal position on firm even ground as well as without a bucket or an attachment (e.g. breaker, etc.).

The lifting force of the vehicle is limited by the hydraulic capacity or by the tilting safety mechanism.

Neither 75% of the static tipping load nor 87% of the hydraulic lifting force are exceeded.

Base of calculation: according to ISO 10567. Set pressure at the lifting arm cylinder: 22500 kPa (3263 psi)

The lifting capability applies for vehicles under the following conditions:

- Lubricants and operating materials at the prescribed levels.
- Full fuel tank.
- Cabin or canopy.
- Vehicle at operating temperature.
- Weight of the operator 75 kg (165 lbs.).



**WACKER
NEUSON**
all it takes!

Lifting force tables EZ38

A B				4.0 m (13'-1")			3.0 m (9'-10")			2.0 m (79 in)		
3.0 m (9'-10")	753 (1,660)	492 (1,085)	412 (908)	736 (1,623)	499 (1,100)	420 (926)	--	--	--	--	--	--
2.0 m (79 in)	773 (1,704)	403 (888)	332 (732)	768 (1,693)	490 (1,080)	410 (904)	862 (1,900)	776 (1,711)	665 (1,466)	--	--	--
1.0 m (39 in)	811 (1,788)	371 (818)	303 (668)	894 (1,971)	466 (1,027)	386 (851)	1235 (2,723)	710 (1,565)	598 (1,318)	--	--	--
0.0 m (0.0 in)	861 (1,898)	378 (833)	308 (679)	995 (2,94)	446 (983)	365 (805)	1478 (3,258)	666 (1,468)	553 (1,219)	2891 (6,374)	1228 (2,707)	1042 (2,297)
-1.0 m (-39 in)	919 (2,026)	435 (959)	356 (785)	958 (2,12)	442 (974)	362 (798)	1472 (3,245)	656 (1,446)	544 (1,99)	2623 (5,783)	1238 (2,729)	1052 (2,319)
-2.0 m (-79 in)	950 (2,094)	640 (1,411)	535 (1,179)	--	--	--	1104 (2,434)	680 (1,499)	568 (1,252)	1938 (4,273)	1279 (2,820)	1094 (2,412)











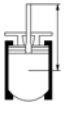

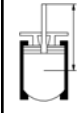
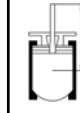
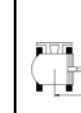
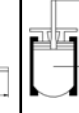

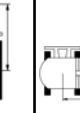

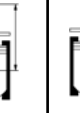
Tab. 1: Lifting force tables EZ38 –short dipper stick

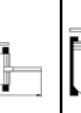
A B				4.0 m (13'-1")			3.0 m (9'-10")			2.0 m (79 in)		
3.0 m (9'-10")	688 (1,517)	443 (977)	363 (800)	637 (1,404)	509 (1,122)	424 (935)	--	--	--	--	--	--
2.0 m (79 in)	712 (1,570)	370 (816)	297 (655)	699 (1,541)	495 (1,091)	409 (902)	--	--	--	--	--	--
1.0 m (39 in)	750 (1,653)	343 (756)	272 (600)	841 (1,854)	468 (1,032)	381 (840)	1135 (2,502)	720 (1,587)	600 (1,323)	--	--	--
0.0 m (0.0 in)	798 (1,759)	348 (767)	274 (604)	968 (2,134)	445 (981)	356 (785)	1433 (3,159)	668 (1,473)	545 (1,202)	2921 (6,440)	1226 (2,703)	1020 (2,249)
-1.0 m (-39 in)	887 (1,955)	392 (864)	311 (686)	988 (2,178)	436 (961)	346 (763)	1493 (3,291)	651 (1,435)	527 (1,162)	2763 (6,091)	1226 (2,703)	1020 (2,249)
-2.0 m (-79 in)	947 (2,088)	556 (1,226)	451 (994)	--	--	--	1169 (2,577)	594 (1,310)	465 (1,025)	2208 (4,868)	1259 (2,776)	1055 (2,326)













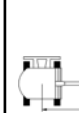
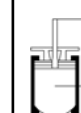
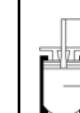

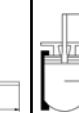
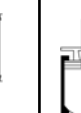
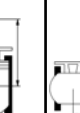

Tab. 2: Lifting force tables EZ38 –long dipper stick



Lifting force tables EZ38

A B				4.0 m (13'-1")			3.0 m (9'-10")			2.0 m (79 in)		
												
												
3.0 m (9'-10")	753 (1,660)	550 (1,213)	473 (1,043)	736 (1,623)	558 (1,230)	481 (1,060)	--	--	--	--	--	--
2.0 m (79 in)	773 (1,704)	454 (1,001)	385 (849)	768 (1,693)	549 (1,210)	471 (1,038)	862 (1,900)	860 (1,896)	754 (1,662)	--	--	--
1.0 m (39 in)	811 (1,788)	420 (926)	354 (780)	894 (1,971)	524 (1,155)	447 (985)	1235 (2,723)	795 (1,753)	687 (1,515)	--	--	--
0.0 m (0.0 in)	861 (1,898)	429 (946)	361 (796)	995 (2,194)	504 (1,111)	426 (939)	1478 (3,258)	751 (1,656)	642 (1,415)	2891 (6,374)	1381 (3,045)	1204 (2,654)
-1.0 m (-39 in)	919 (2,026)	492 (1,085)	416 (917)	958 (2,112)	501 (1,105)	423 (933)	1472 (3,245)	741 (1,634)	632 (1,393)	2623 (5,783)	1391 (3,067)	1215 (2,679)
-2.0 m (-79 in)	950 (2,094)	720 (1,587)	618 (1,362)	--	--	--	1104 (2,434)	765 (1,687)	657 (1,448)	1938 (4,273)	1432 (3,157)	1257 (2,771)

Tab. 3: Lifting force tables EZ38 –short dipper stick and additional rear weight

A B				4.0 m (13'-1")			3.0 m (9'-10")			2.0 m (79 in)		
												
												
3.0 m (9'-10")	688 (1,517)	496 (1,093)	425 (937)	637 (1,404)	567 (1,250)	490 (1,080)	--	--	--	--	--	--
2.0 m (79 in)	712 (1,570)	418 (922)	353 (778)	699 (1,541)	553 (1,219)	476 (1,049)	--	--	--	--	--	--
1.0 m (39 in)	750 (1,653)	389 (858)	327 (721)	841 (1,854)	527 (1,162)	449 (990)	1135 (2,502)	805 (1,775)	697 (1,537)	--	--	--
0.0 m (0.0 in)	798 (1,759)	396 (873)	331 (730)	968 (2,134)	503 (1,109)	425 (937)	1433 (3,159)	753 (1,660)	644 (1,420)	2921 (6,440)	1379 (3,040)	1202 (2,650)
-1.0 m (-39 in)	887 (1,955)	445 (981)	374 (825)	988 (2,178)	494 (1,089)	416 (917)	1493 (3,291)	736 (1,623)	627 (1,382)	2763 (6,091)	1379 (3,040)	1202 (2,650)
-2.0 m (-79 in)	947 (2,088)	627 (1,382)	535 (1,179)	--	--	--	1169 (2,577)	679 (1,497)	569 (1,254)	2208 (4,868)	1412 (3,113)	1236 (2,725)

Tab. 4: Lifting force tables EZ38 –long dipper stick and additional rear weight



Lifting force tables EZ38

A B				4.0 m (13'-1")			3.0 m (9'-10")			2.0 m (79 in)		
3.0 m (9'-10")	740 (1,631)	529 (1,166)	454 (1,001)	730 (1,609)	546 (1,204)	470 (1,036)	--	--	--	--	--	--
2.0 m (79 in)	769 (1,695)	440 (970)	373 (822)	777 (1,713)	535 (1,179)	458 (1,010)	890 (1,962)	838 (1,847)	732 (1,614)	--	--	--
1.0 m (39 in)	811 (1,788)	409 (902)	344 (758)	904 (1,993)	510 (1,124)	433 (955)	1263 (2,784)	772 (1,702)	665 (1,466)	--	--	--
0.0 m (0.0 in)	866 (1,909)	421 (928)	353 (778)	999 (2,202)	491 (1,082)	414 (913)	1487 (3,278)	731 (1,612)	624 (1,376)	2879 (6,347)	1349 (2,974)	1174 (2,588)
-1.0 m (-39 in)	934 (2,059)	488 (1,076)	411 (906)	940 (2,072)	490 (1,080)	413 (911)	1460 (3,219)	724 (1,596)	616 (1,358)	2588 (5,706)	1361 (3,000)	1186 (2,615)
-2.0 m (-79 in)	998 (2,200)	737 (1,625)	632 (1,393)	--	--	--	1033 (2,277)	752 (1,658)	645 (1,422)	1848 (4,074)	1405 (3,097)	1232 (2,716)

Tab. 5: Lifting force tables EZ38 –short dipper stick and vertical digging system (VDS)

A B				4.0 m (13'-1")			3.0 m (9'-10")			2.0 m (79 in)		
3.0 m (9'-10")	672 (1,482)	473 (1,043)	403 (888)	631 (1,391)	549 (1,210)	473 (1,043)	--	--	--	--	--	--
2.0 m (79 in)	701 (1,545)	399 (880)	336 (741)	702 (1,548)	533 (1,175)	457 (1,008)	--	--	--	--	--	--
1.0 m (39 in)	742 (1,636)	372 (820)	311 (686)	845 (1,863)	505 (1,113)	428 (944)	1156 (2,549)	772 (1,702)	666 (1,468)	--	--	--
0.0 m (0.0 in)	794 (1,750)	380 (838)	316 (697)	965 (2,127)	481 (1,060)	404 (891)	1434 (3,161)	721 (1,590)	614 (1,354)	2899 (6,391)	1326 (2,923)	1150 (2,535)
-1.0 m (-39 in)	860 (1,896)	432 (952)	361 (796)	971 (2,141)	473 (1,043)	396 (873)	1473 (3,247)	706 (1,556)	598 (1,318)	2713 (5,981)	1329 (2,930)	1154 (2,544)
-2.0 m (-79 in)	936 (2,064)	602 (1,327)	511 (1,127)	--	--	--	1199 (2,643)	724 (1,596)	616 (1,358)	2115 (4,663)	1366 (3,012)	1192 (2,628)

Tab. 6: Lifting force tables EZ38 –long dipper stick and vertical digging system (VDS)



Lifting force tables EZ38

A B				4.0 m (13'-1")			3.0 m (9'-10")			2.0 m (79 in)		
3.0 m (9'10")	740 (1,631)	587 (1,294)	514 (1,133)	730 (1,609)	605 (1,334)	531 (1,171)	--	--	--	--	--	--
2.0 m (79 in)	769 (1,695)	491 (1,082)	426 (939)	777 (1,713)	593 (1,307)	519 (1,144)	890 (1,962)	890 (1,962)	821 (1,810)	--	--	--
1.0 m (39 in)	811 (1,788)	458 (1,010)	395 (871)	904 (1,993)	569 (1,254)	494 (1,089)	1263 (2,784)	856 (1,887)	754 (1,662)	--	--	--
0.0 m (0.0 in)	866 (1,909)	472 (1,041)	406 (895)	999 (2,202)	549 (1,210)	475 (1,047)	1487 (3,278)	816 (1,799)	712 (1,570)	2879 (6,347)	1502 (3,311)	1337 (2,948)
-1.0 m (-39 in)	934 (2,059)	546 (1,204)	472 (1,041)	940 (2,072)	548 (1,208)	474 (1,045)	1460 (3,219)	808 (1,781)	705 (1,554)	2588 (5,706)	1514 (3,338)	1349 (2,974)
-2.0 m (-79 in)	998 (2,200)	820 (1,808)	719 (1,585)	--	--	--	1033 (2,277)	837 (1,845)	734 (1,618)	1848 (4,074)	1558 (3,435)	1395 (3,075)

Tab. 7: Lifting force tables EZ38 –short dipper stick, additional rear weight and vertical digging system (VDS)

A B				4.0 m (13'-1")			3.0 m (9'-10")			2.0 m (79 in)		
3.0 m (9'10")	672 (1,482)	525 (1,157)	458 (1,010)	631 (1,391)	608 (1,340)	534 (1,177)	--	--	--	--	--	--
2.0 m (79 in)	701 (1,545)	447 (985)	385 (849)	702 (1,548)	591 (1,303)	517 (1,140)	--	--	--	--	--	--
1.0 m (39 in)	742 (1,636)	419 (924)	359 (791)	845 (1,863)	563 (1,241)	489 (1,078)	1156 (2,549)	857 (1,889)	755 (1,664)	--	--	--
0.0 m (0.0 in)	794 (1,750)	428 (944)	366 (807)	965 (2,127)	539 (1,188)	465 (1,025)	1434 (3,161)	806 (1,777)	702 (1,548)	2899 (6,391)	1479 (3,261)	1313 (2,895)
-1.0 m (-39 in)	860 (1896)	485 (1,069)	416 (917)	971 (2,141)	532 (1,173)	457 (1,008)	1473 (3,247)	791 (1,744)	687 (1,515)	2713 (5,981)	1482 (3,267)	1316 (2,901)
-2.0 m (-79 in)	936 (2,064)	674 (1,486)	585 (1,290)	--	--	--	1199 (2,643)	808 (1,781)	705 (1,554)	2115 (4,663)	1519 (3,349)	1355 (2,987)

Tab. 8: Lifting force tables EZ38 –long dipper stick, additional rear weight and vertical digging system (VDS)